

X60 L7 Basic

Art. No. 80.50.405

**Waste separation system
for pre-existing rails**

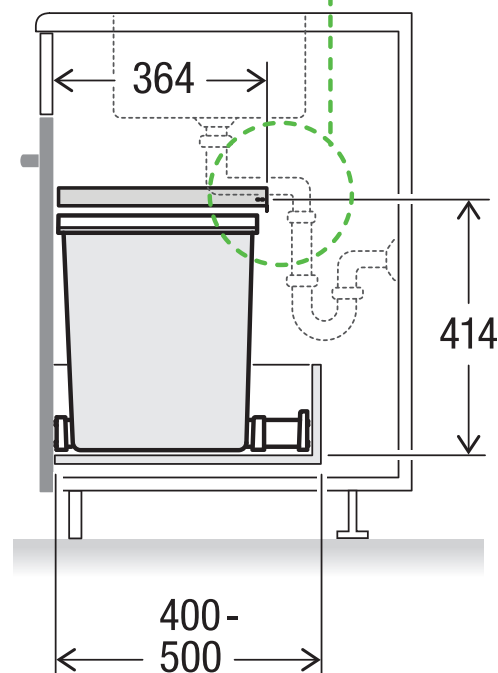
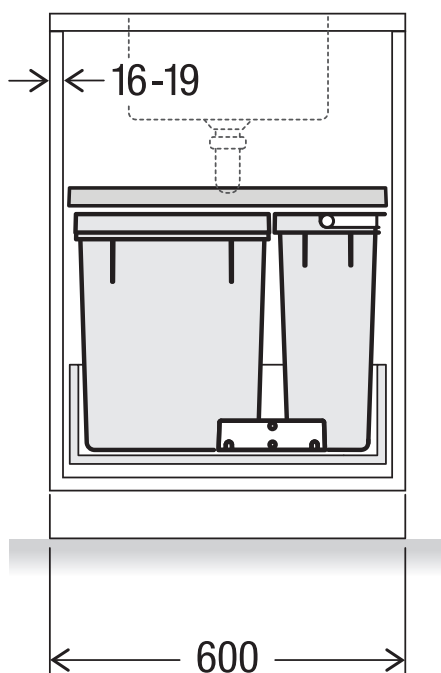
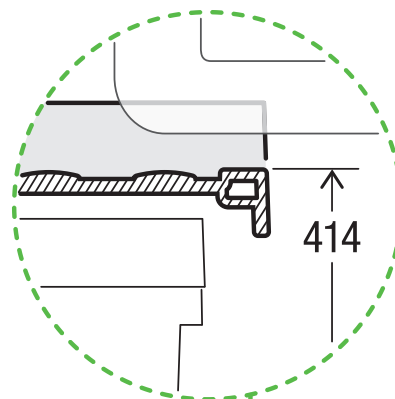
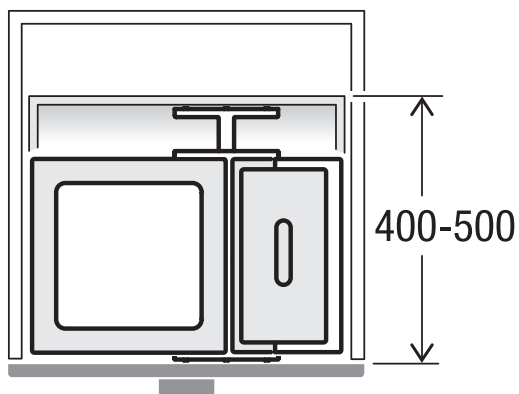

MÜLLEX

A. & J. Stöckli AG · Ennetbachstrasse 40 · CH-8754 Netstal
+41 55 645 55 80 · info@muellex.ch · muellex.ch